



Manyara

Produktdaten

Product Information
Information produits

Bretz
True Characters

Der Ferne so nah



Z 101 li Manyara ▶ 341 cm ▼ 190 cm ▲ 85 cm
Stoff · Fabric · Tissu 67 7119

"Zieh dich zurück inmitten dieses wilden, schönen Seins. Ich bin dir Heimat auf der Safari, die da Leben heißt. Ich halte dich fest, damit du loslassen kannst", scheint Manyara zu flüstern und türmt ihre Kissen. Ihre Stoffe reflektieren die Farben Afrikas unter der tief liegenden Sonne, die Sinne gehen auf Reisen. Manyara zelebriert die Stille als Quell der Abenteuerlust. Hier finden Ideen Raum zur Entfaltung, Momente von gestern klingen nach und Impulse für morgen entstehen – vielleicht sogar für den ein oder anderen, großen oder kleinen Aufbruch. Denn aus Geborgenheit wächst Freiheit.

Collection **Manyara**



G 101 Manyara ▶ 360 cm ▼ 190 cm ▲ 85 cm
Stoff · Fabric · Tissu 67 7117

“Come, rest awhile within this wild and beautiful creation. I’m your sanctuary on safari – the life of this place. I’ll hold you tight, so you can let go,” Manyara seems to whisper, drawing you down into her cushions. Her fabrics echo the colors of Africa with the sun low in the sky... the senses take flight. Manyara celebrates the quiet reflection from which we draw our spirit of adventure.

A place where ideas can find room to breathe, where yesterday’s reminiscences flicker back into life, where plans for tomorrow are hatched. And maybe new beginnings, big or small? A safe haven from which freedom sets sail.



F 101 Manyara ▶ 245 cm ▼ 129 cm ▲ 85 cm
Stoff · Fabric · Tissu 67 7119

The faraway at your fingertips



Le lointain tout proche



A 104 - C 104 R Balaoo ▶ 95 cm ▼ 38 cm ▲ 77 cm
Stoff · Fabric · Tissu 67 8055

« Réfugie-toi au coeur de cet état sauvage et beau. Je suis ton pays dans ce safari qu'est la vie. Je te tiens solidement pour que tu puisses lâcher prise », semble chuchoter Manyara en empilant ses coussins. Ses tissus revêtent les couleurs de l'Afrique sous le soleil couchant, les sens partent en voyage. Manyara célèbre le silence comme l'étincelle du désir d'aventure. Ici, les idées trouvent la place de s'épanouir, des instants d'hier retentissent pendant que l'élan pour demain voit le jour - peut-être même pour un départ, insignifiant ou d'envergure. Car la liberté naît du sentiment de sécurité.



H 101 li Manyara ▶ 346 cm ▼ 222 cm ▲ 85 cm
Stoff · Fabric · Tissu 67 7153



Facts & Highlights

- Loungeatmosphäre durch übergroße, gestapelte Sitz- und großzügige Rückenkissen
- In den drei Lagen des Sitzes verbirgt sich ein Aufbau aus Mehrfach-Federung und Premiumschäumen
- Modulares Sofasystem bestehend aus rechteckigen und polygonalen Anbauteilen
- Durch die Wahl des Fußes können unterschiedliche Sitzhöhen realisiert werden
- Lounge atmosphere thanks to oversized, stacked seat cushions and generous back cushions
- The three layers of the seat conceal a structure consisting of several spring cores and premium foams
- Modular sofa system consisting of rectangular and polygonal add-on parts
- Different seat heights can be realized by selecting the appropriate base
- Atmosphère lounge grâce aux coussins d'assise surdimensionnés, empilés et aux coussins de dossier généreux
- Les trois couches de l'assise cachent une structure composée de plusieurs noyaux de ressorts et de mousses premium
- Système de canapés modulaires composé d'éléments rapportés rectangulaires et polygonaux
- Possibilité de réaliser différentes hauteurs d'assise en choisissant un piètement différent

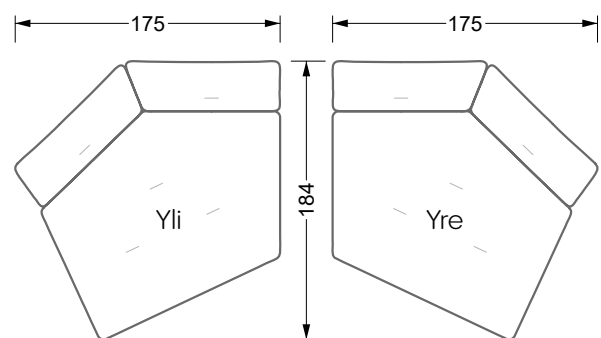
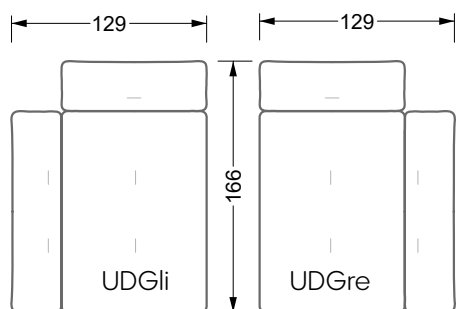
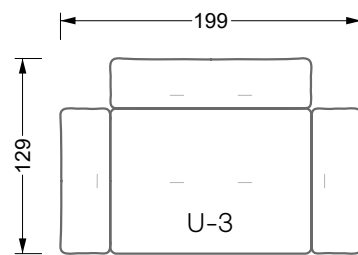
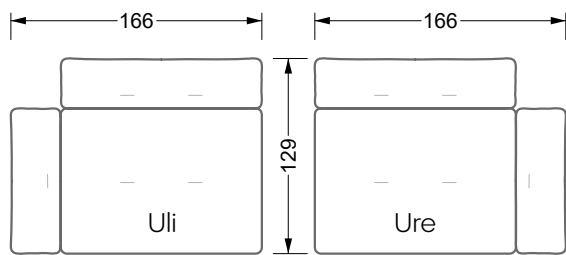
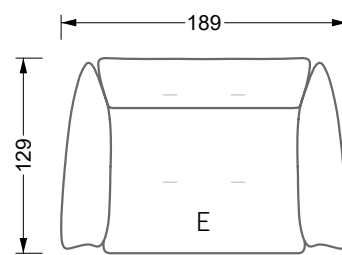
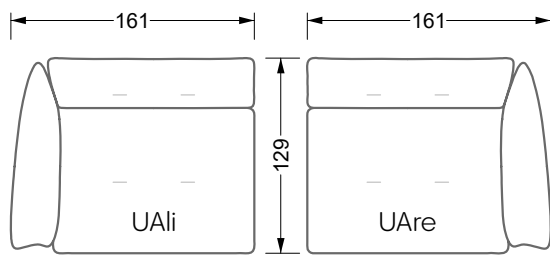
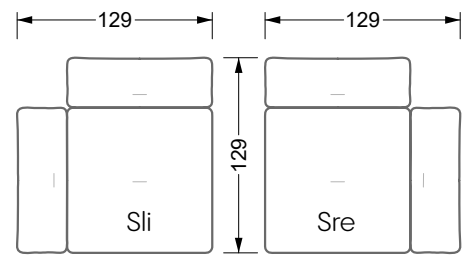
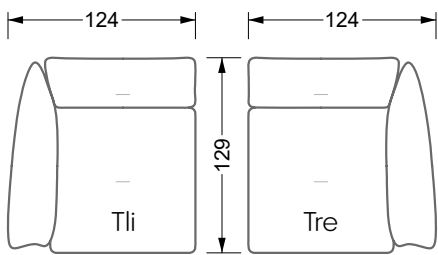
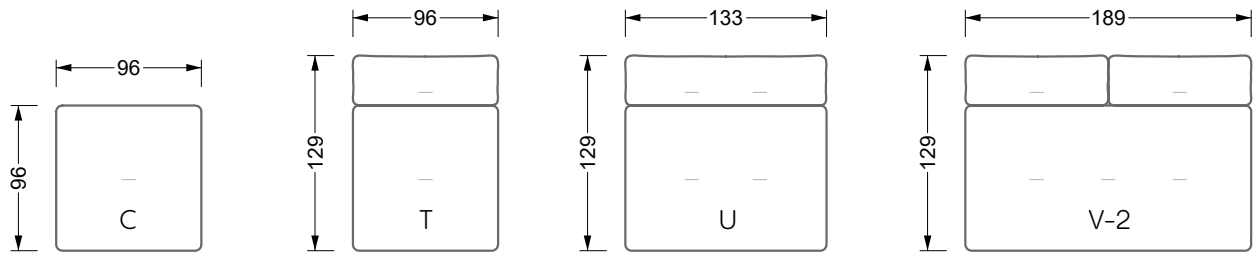

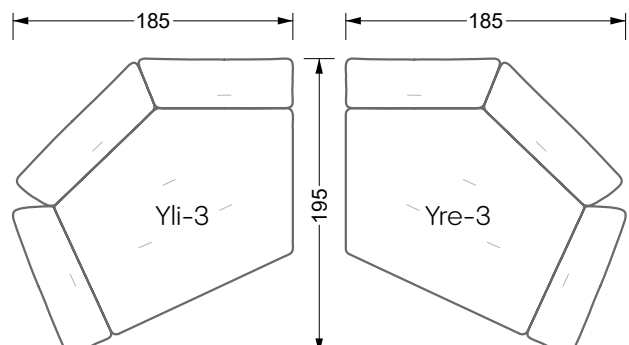
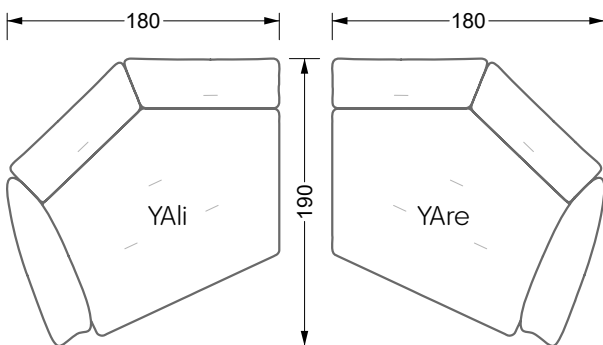
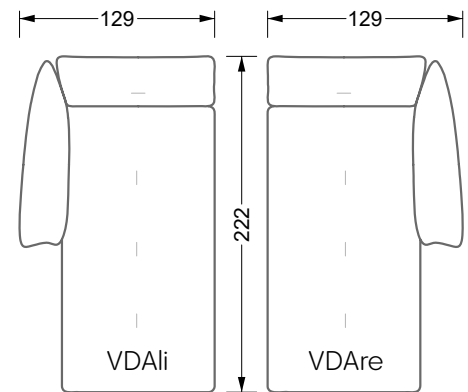
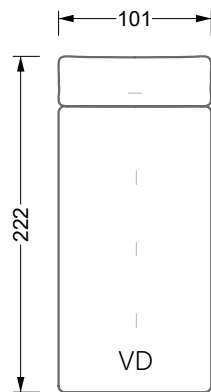
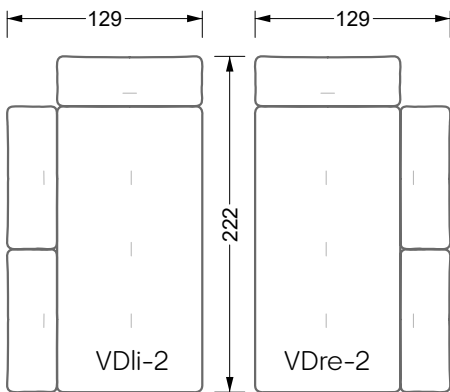
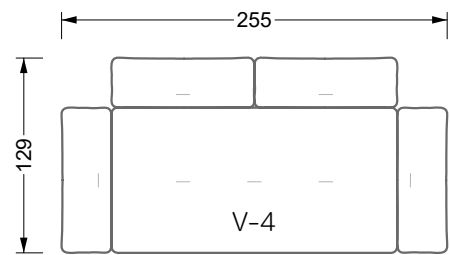
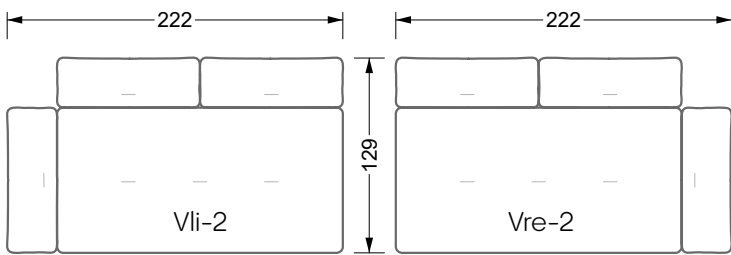
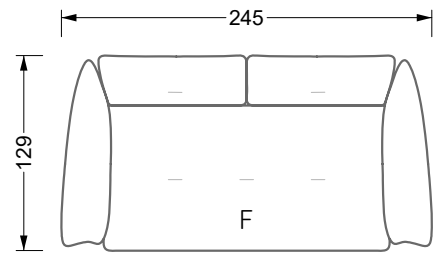
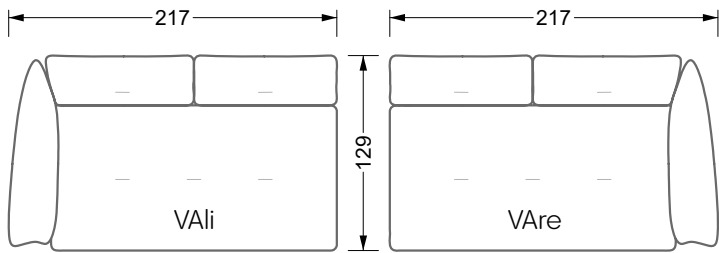

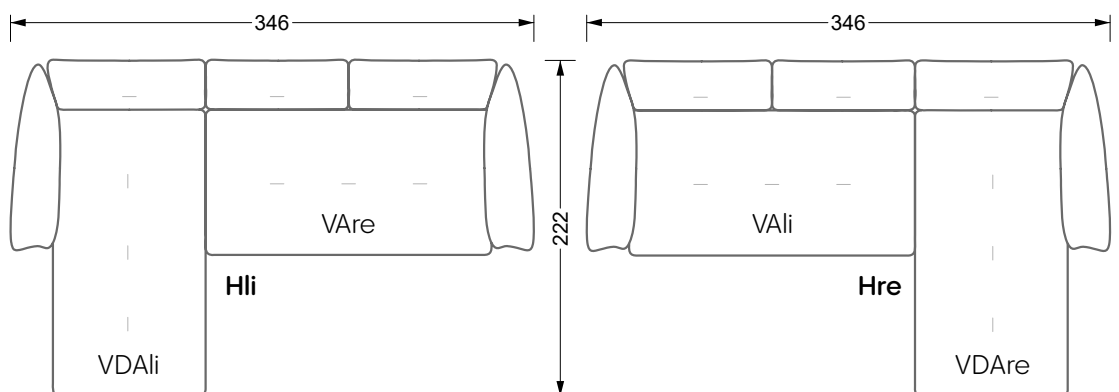
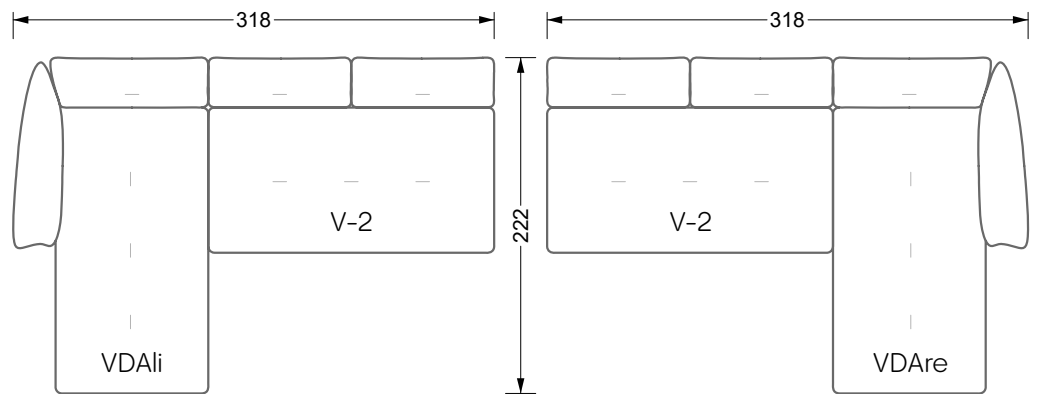
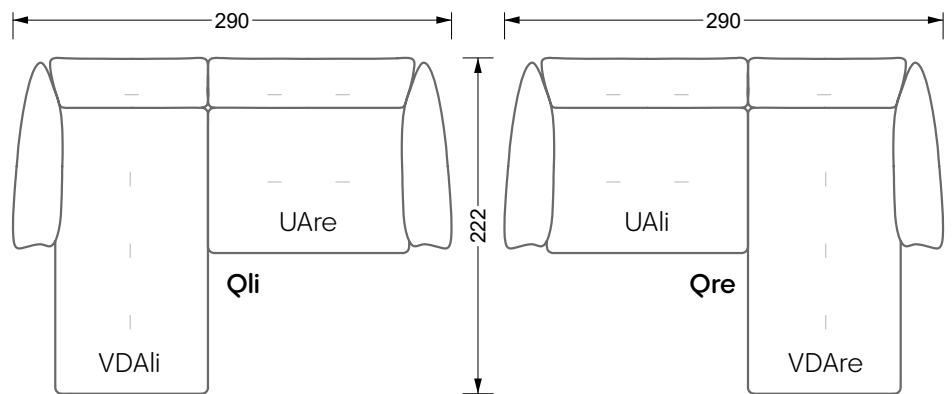
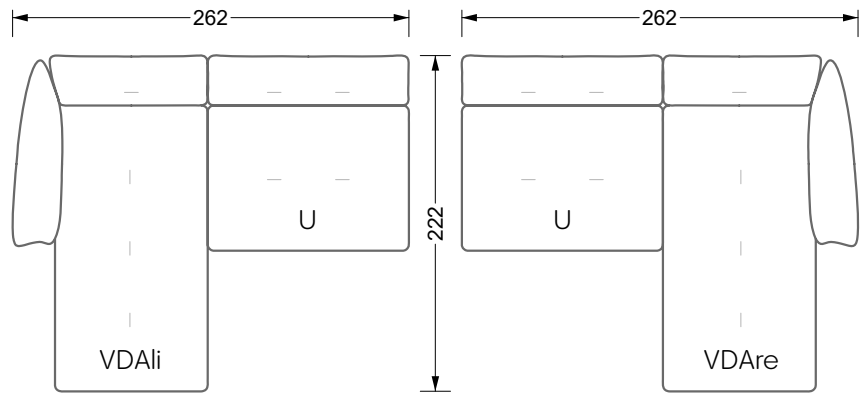
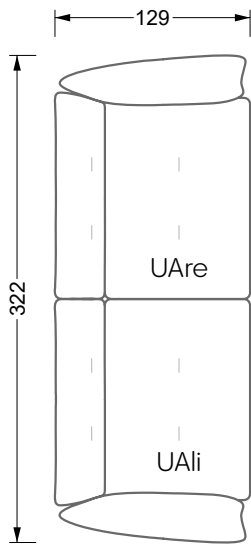

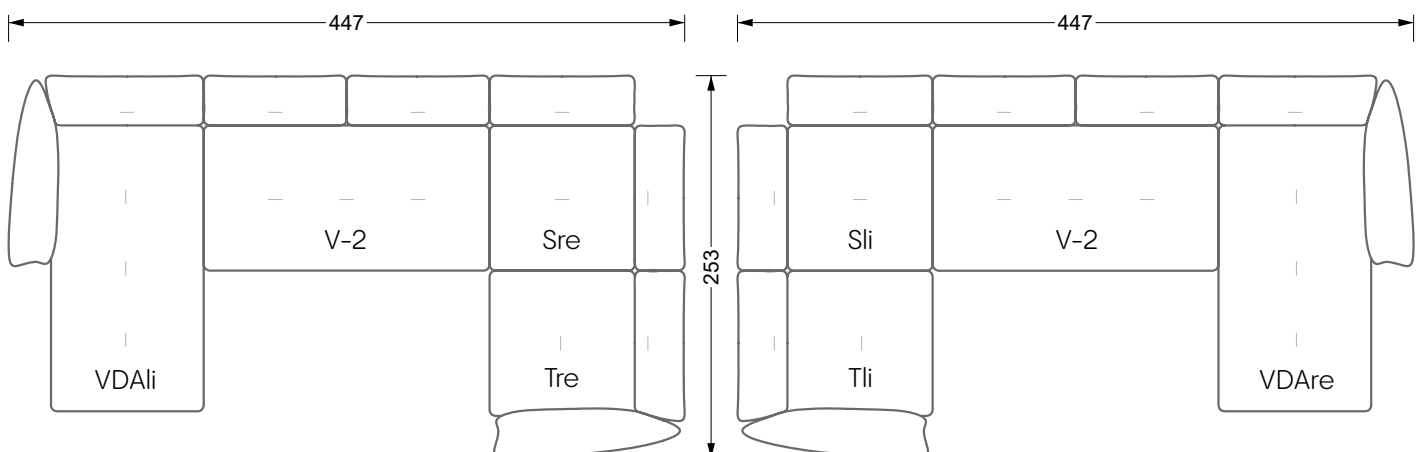
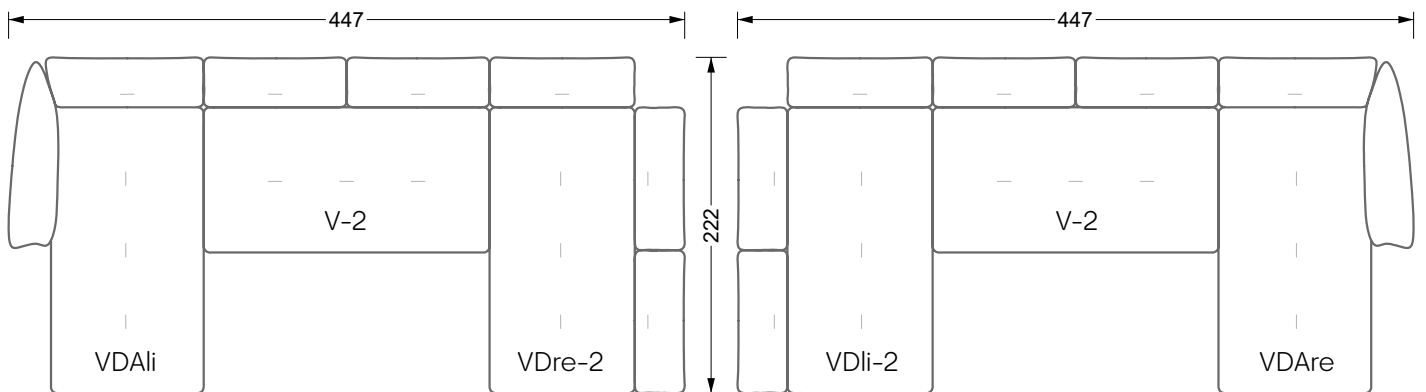
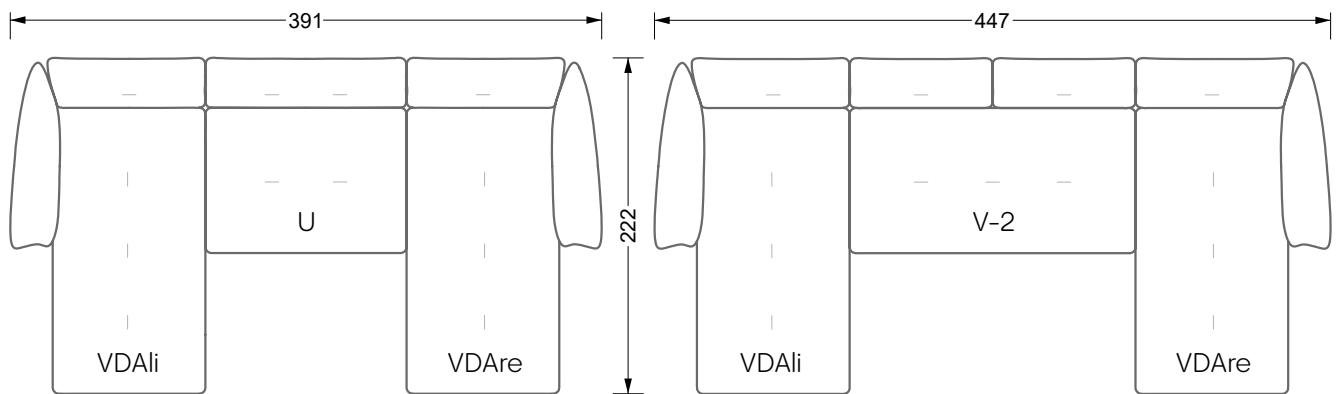
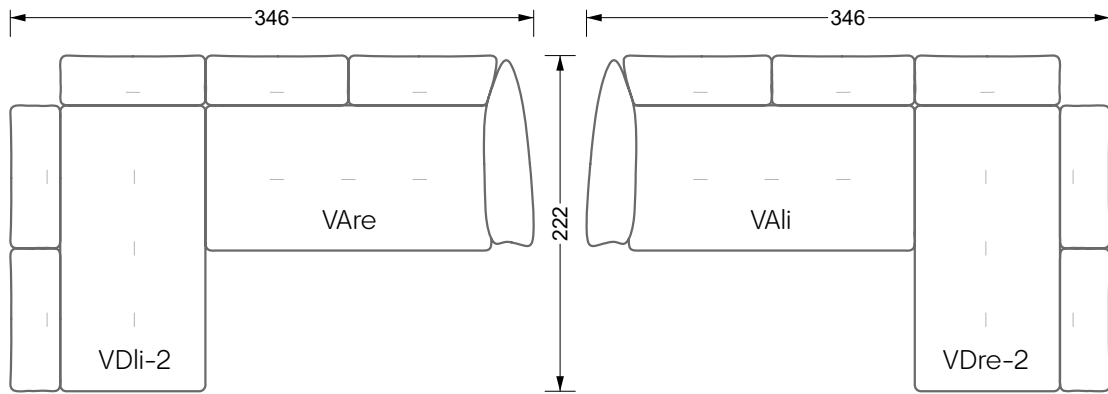

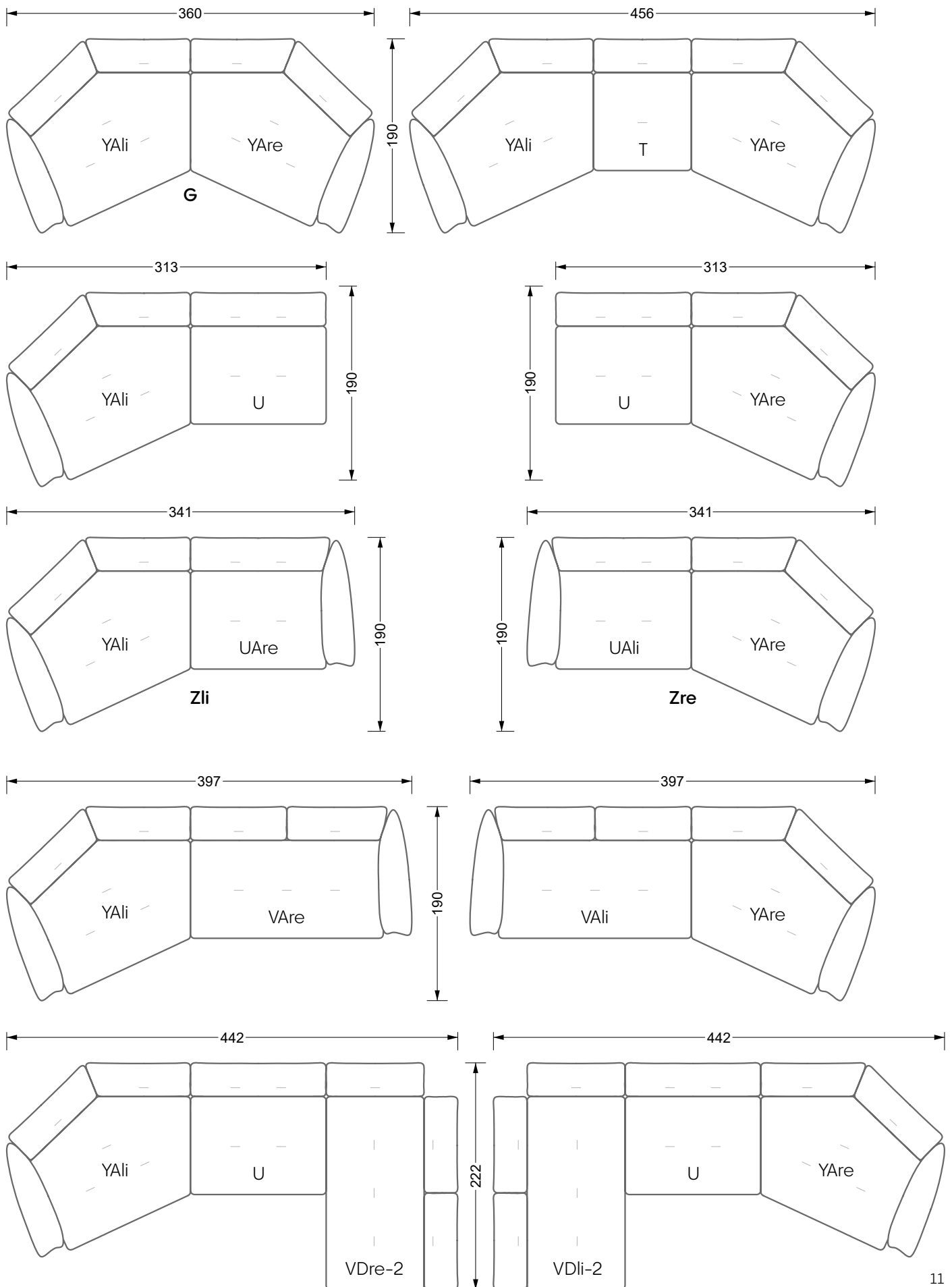

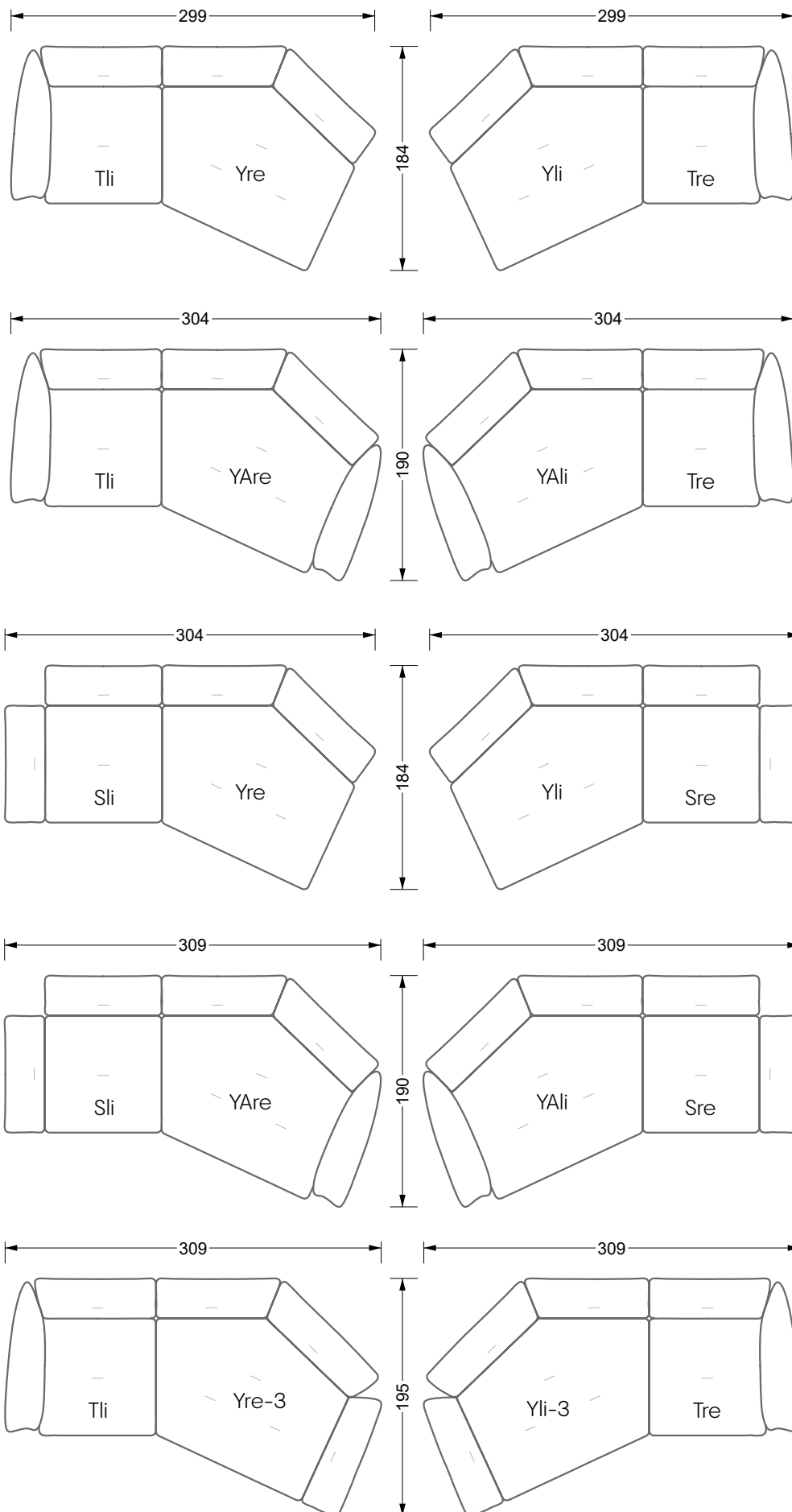

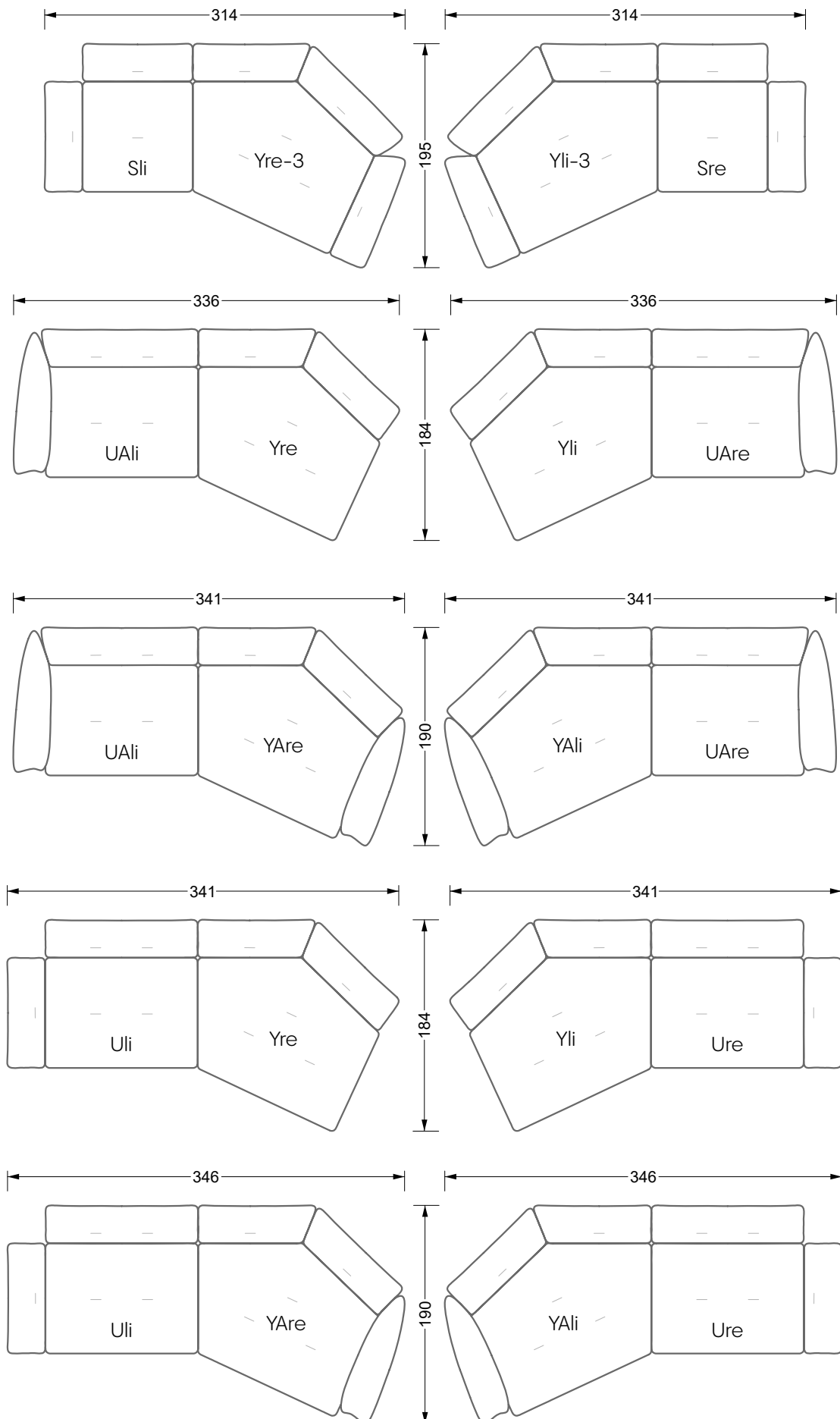

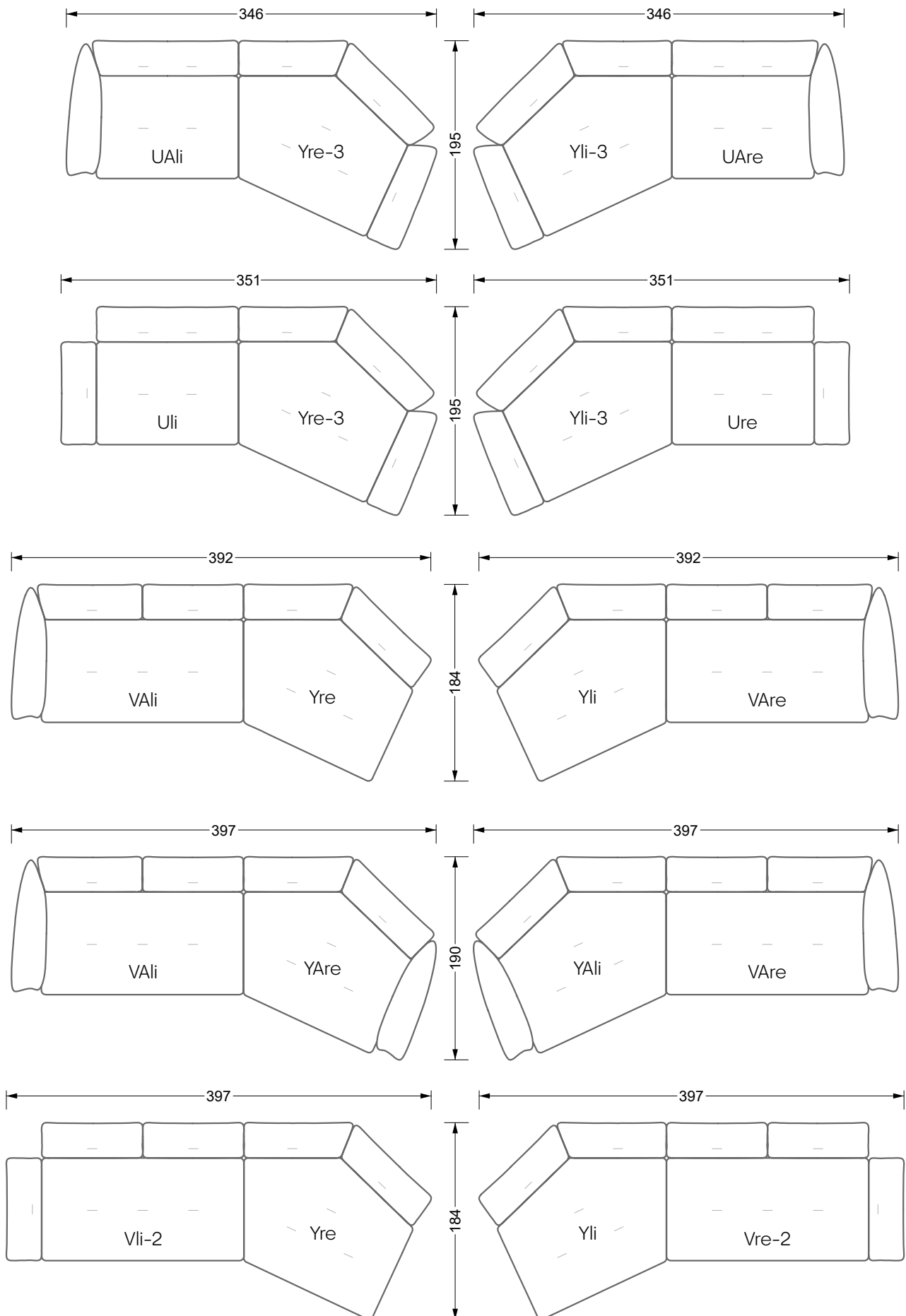

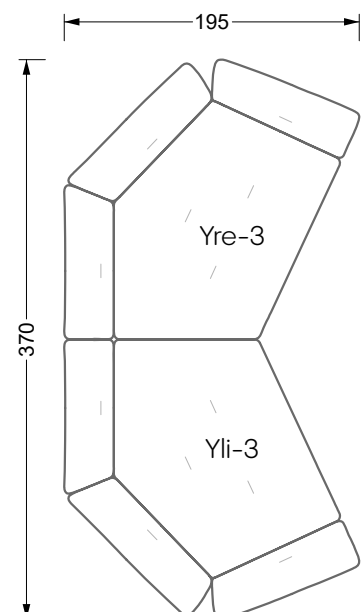
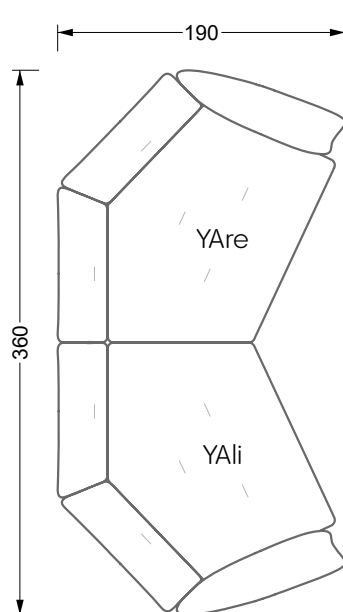
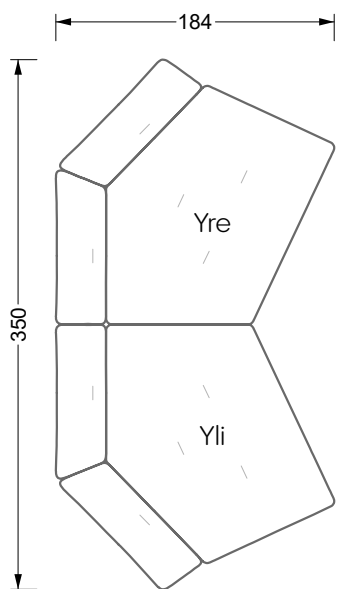
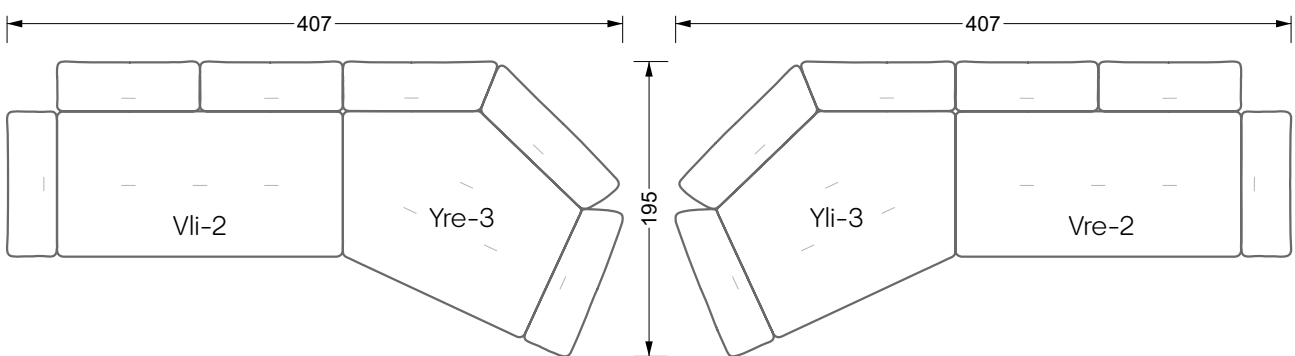
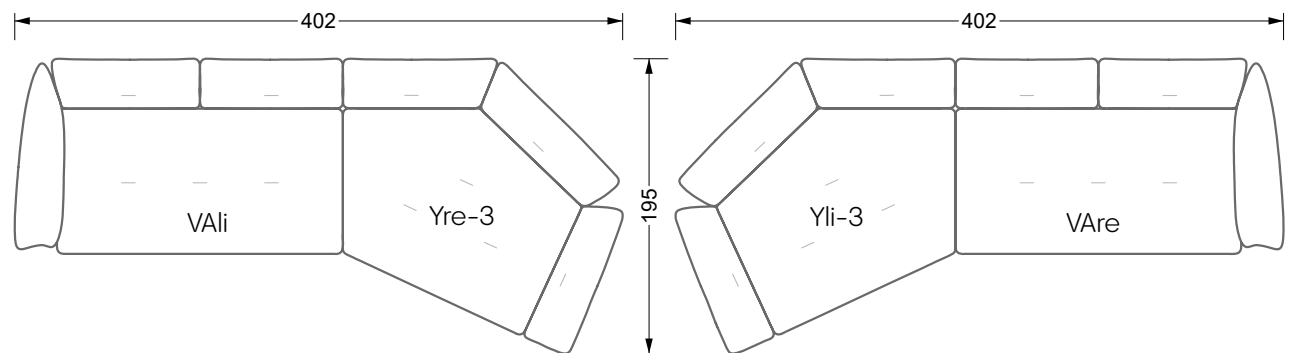
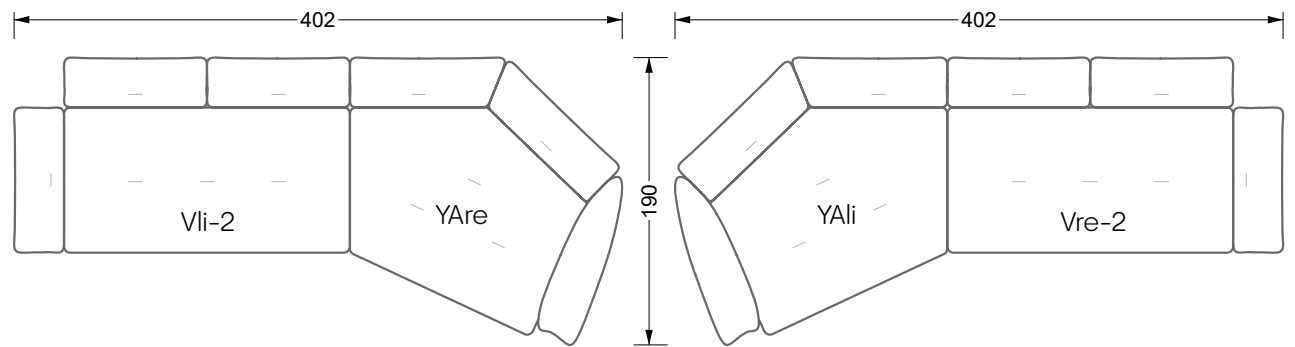

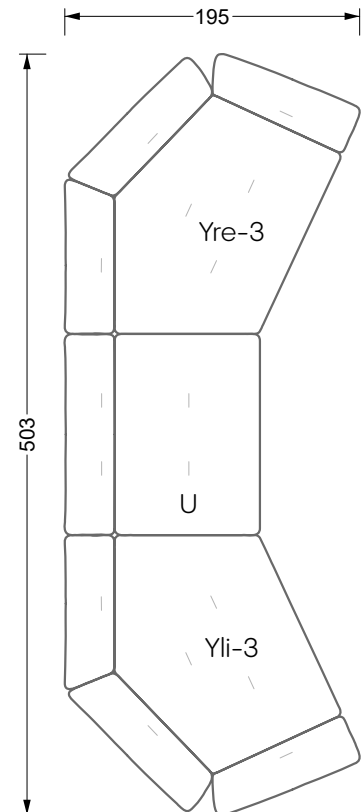
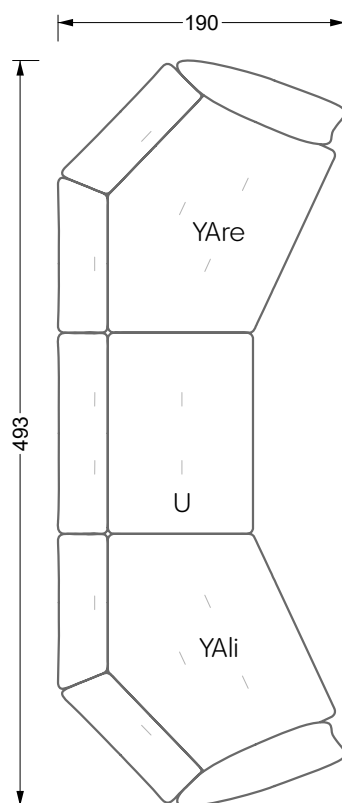
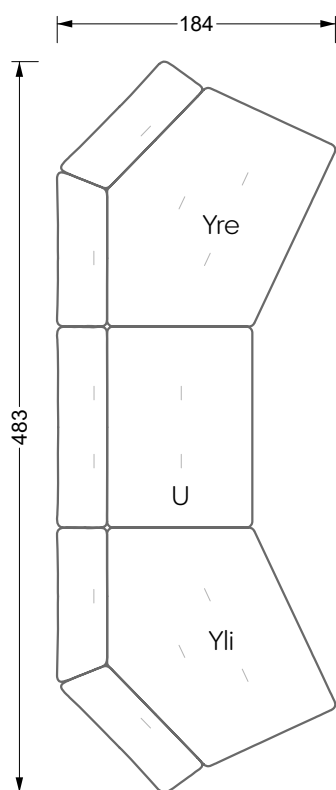
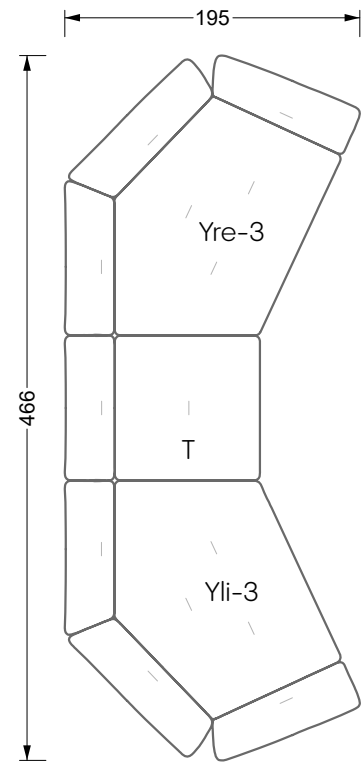
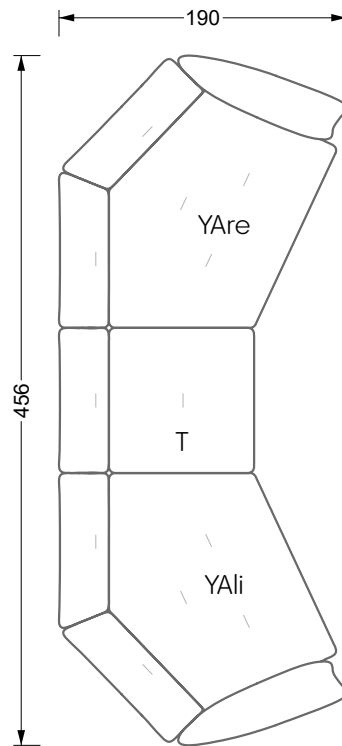
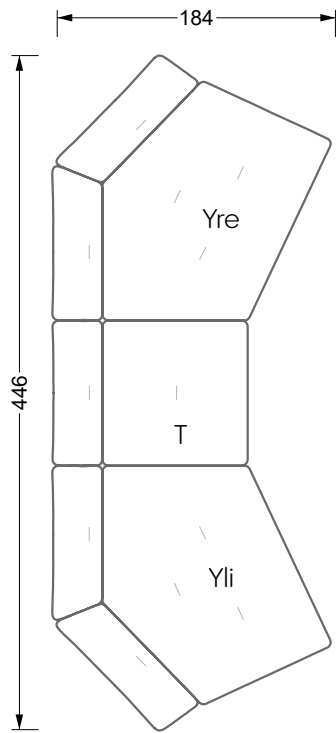

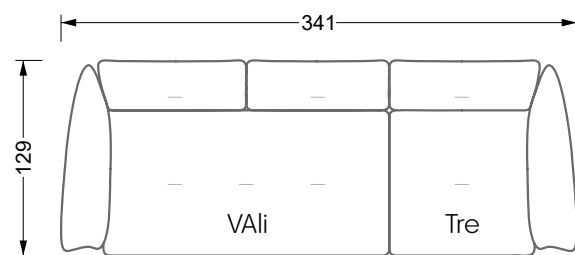
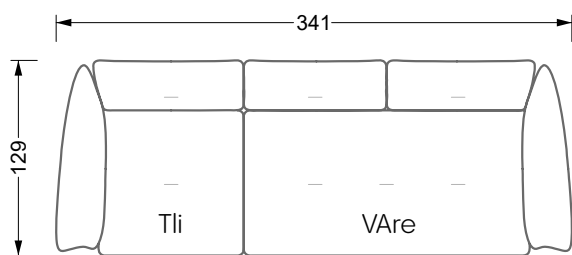
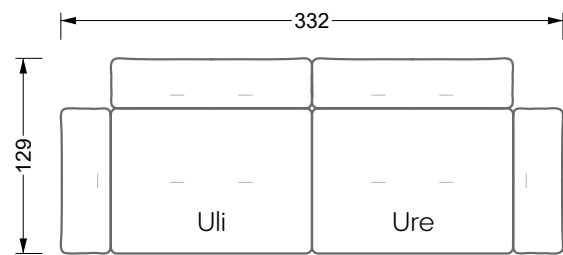
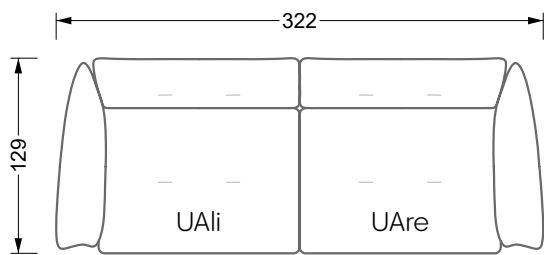
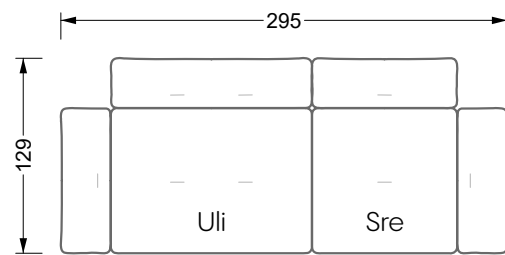
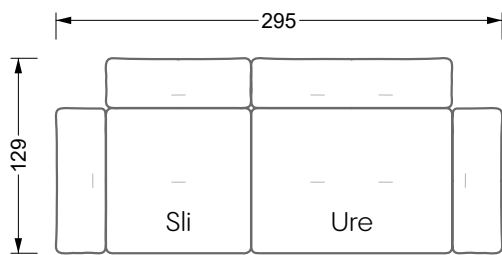
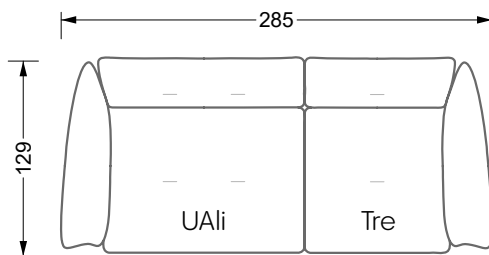
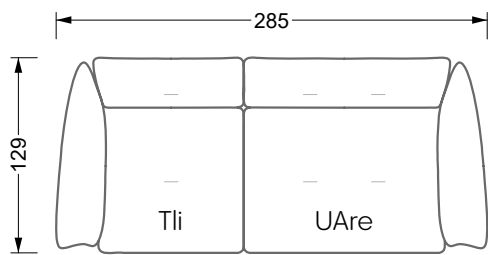
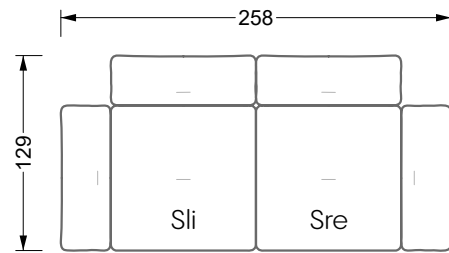
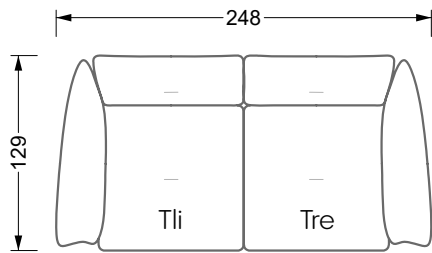

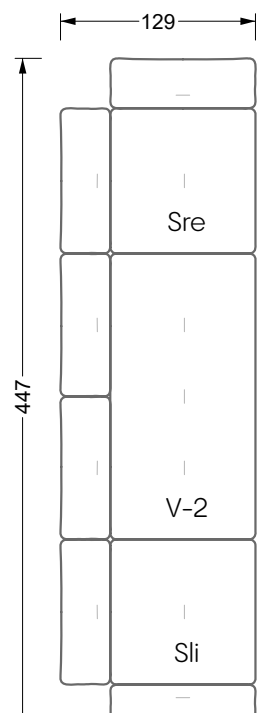
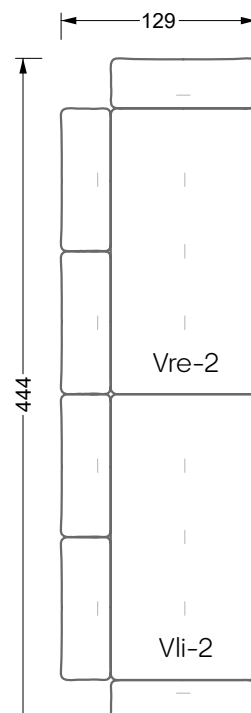
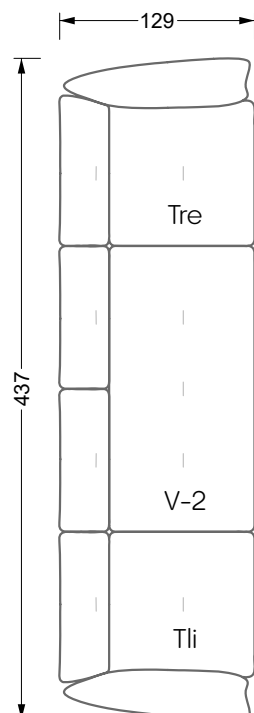
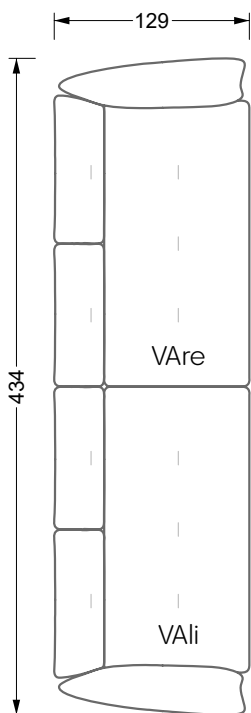
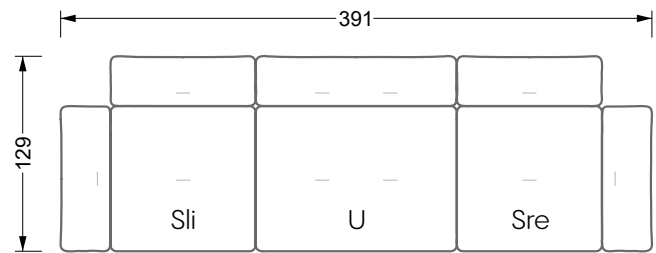
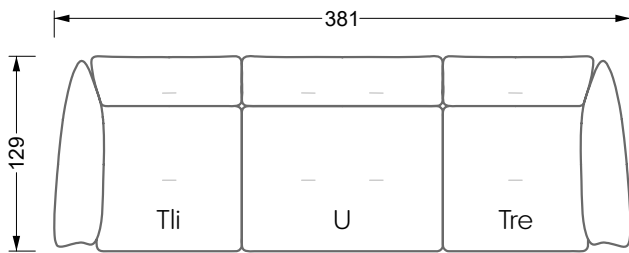
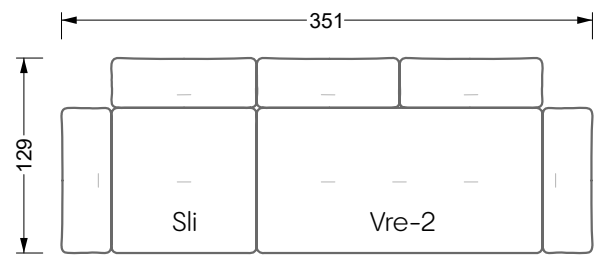
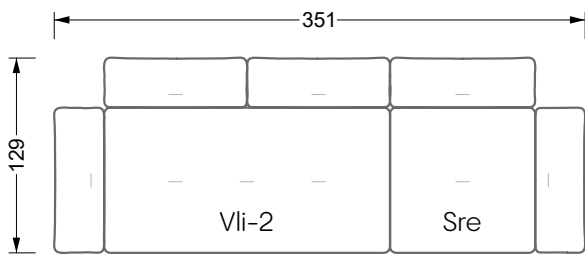
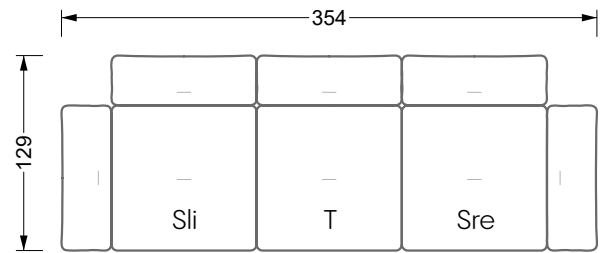
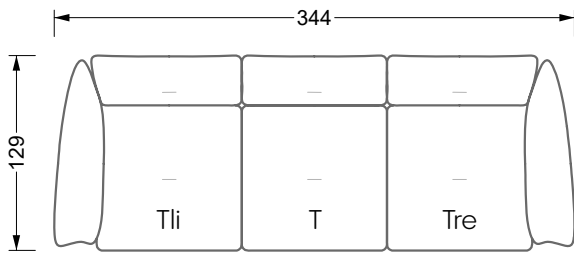

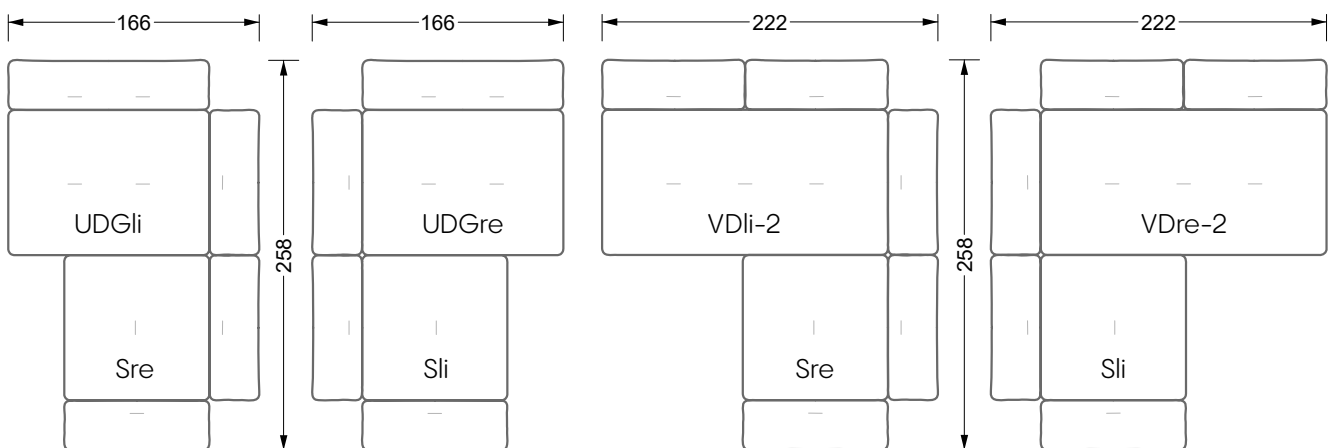
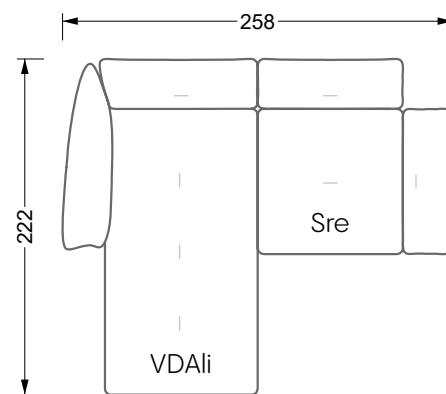
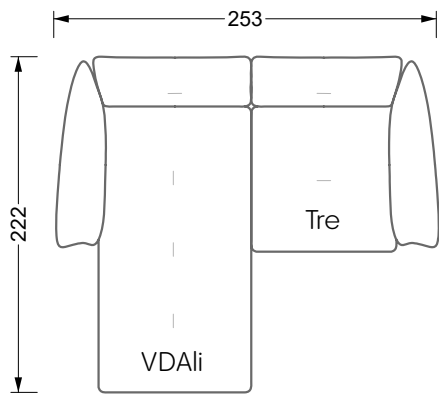
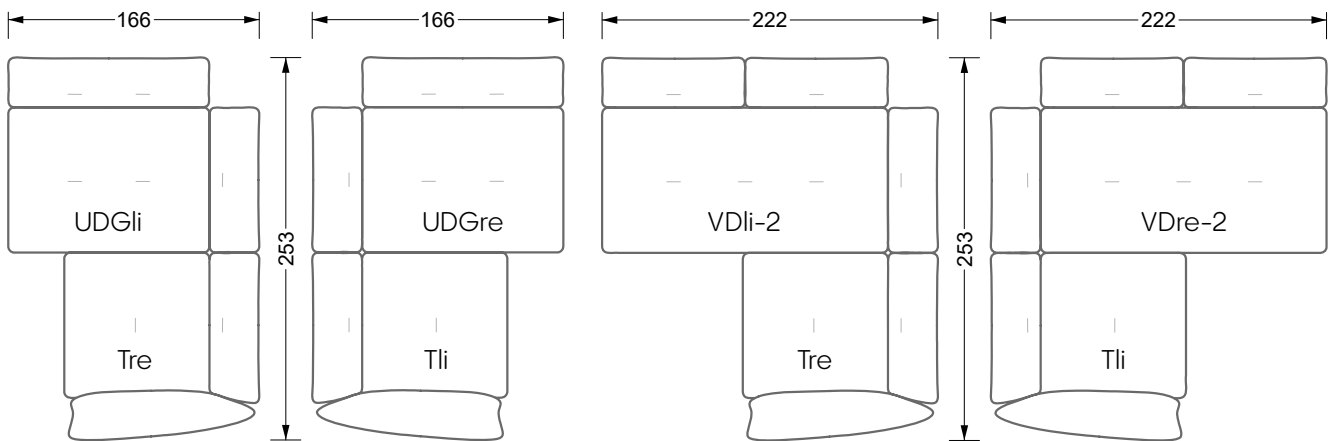

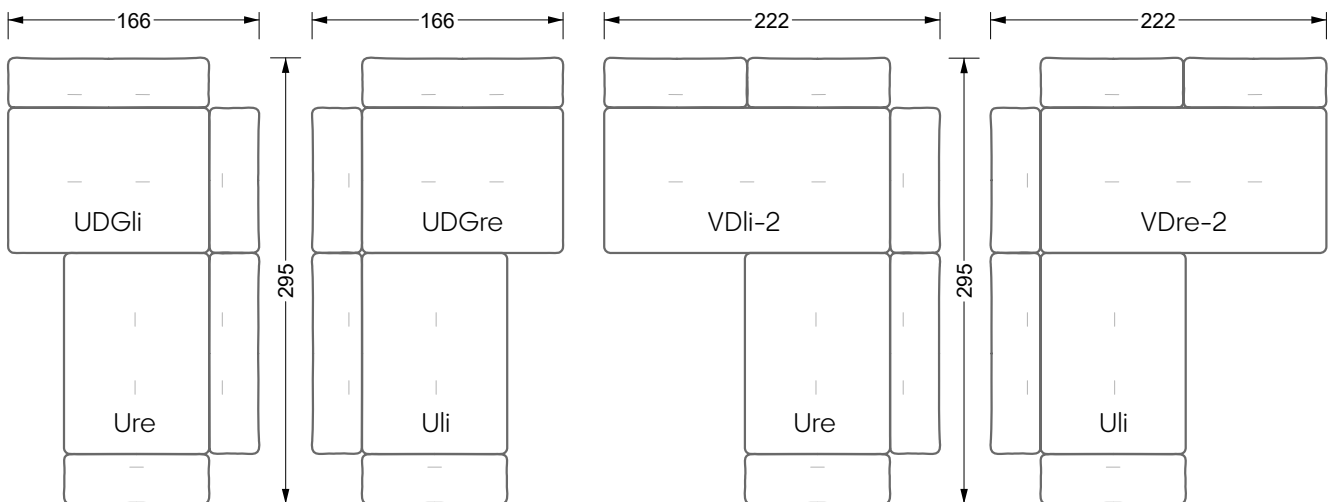
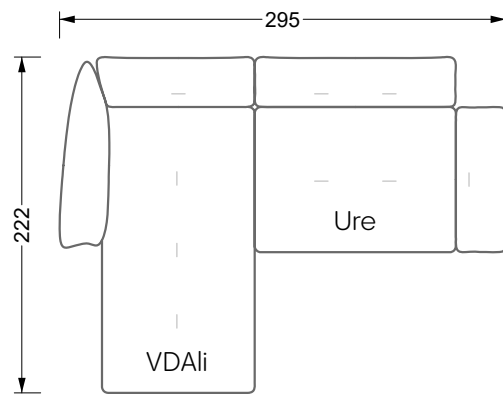
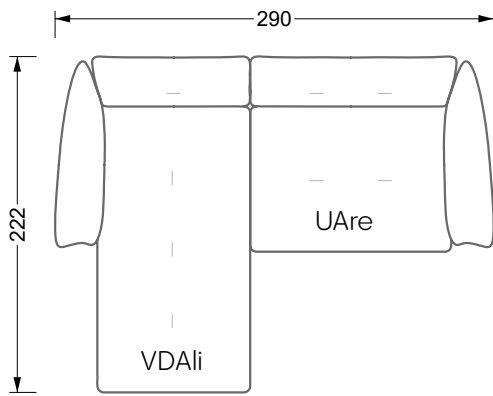
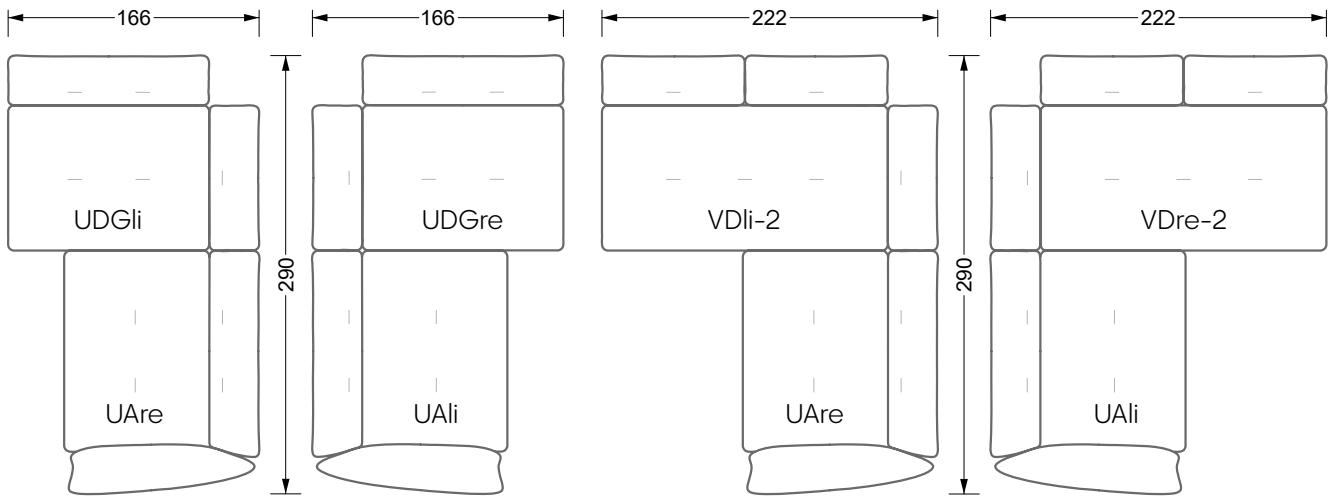

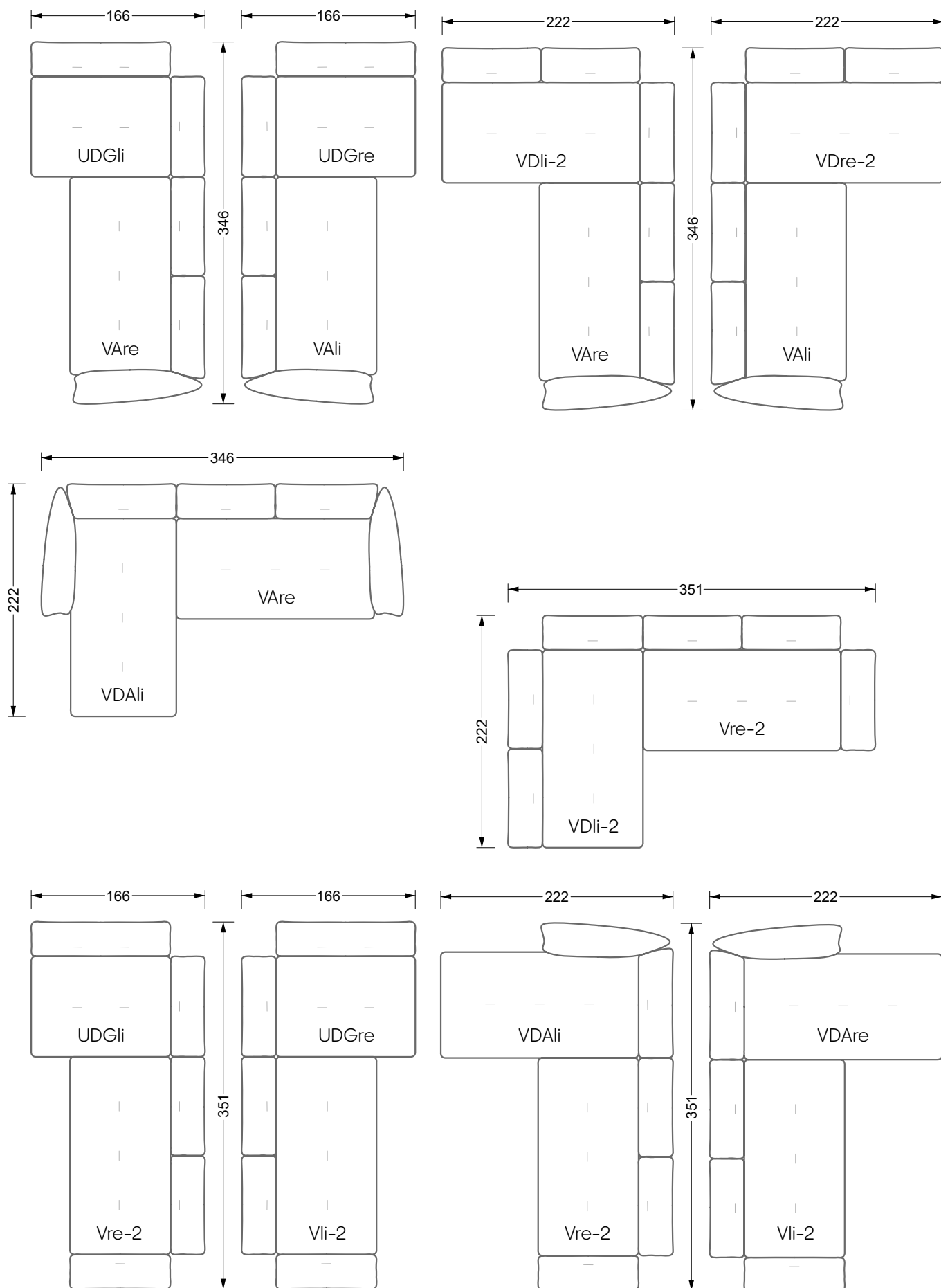

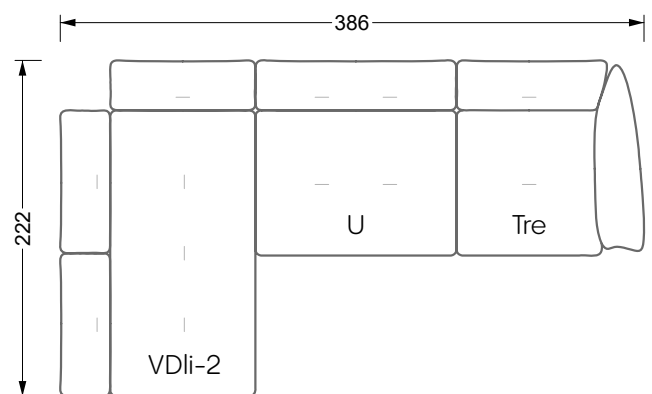
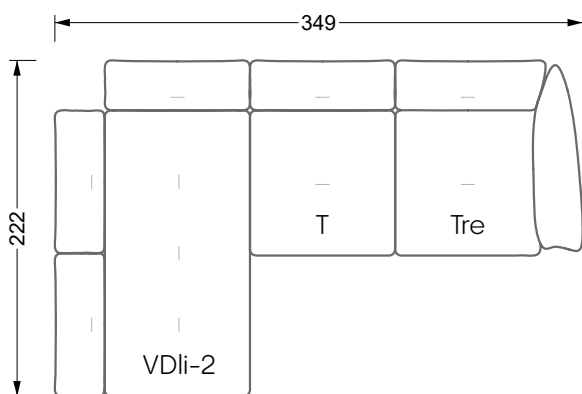
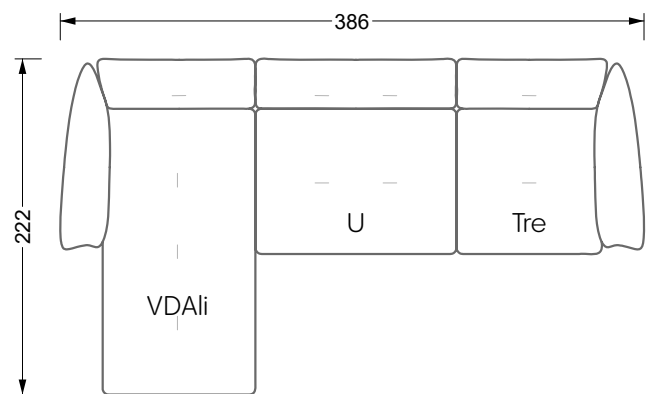
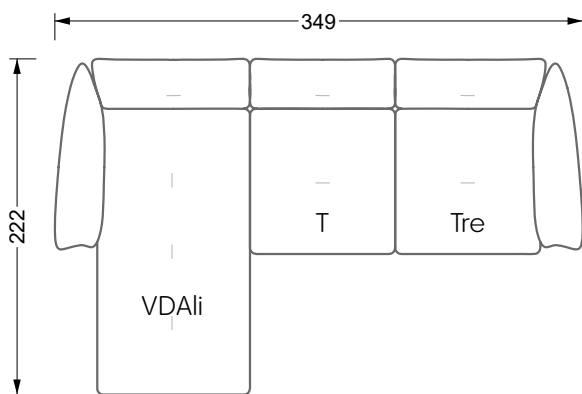
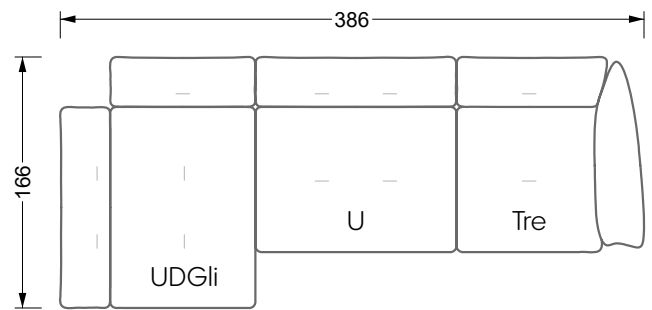
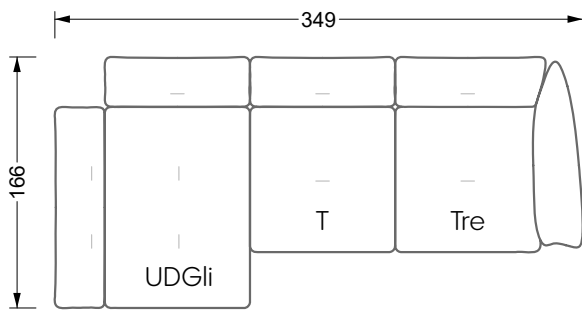
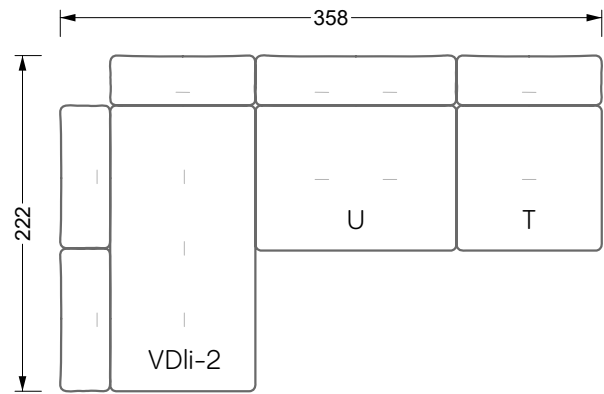
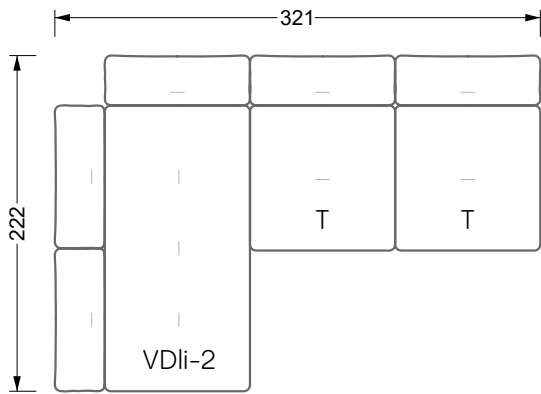

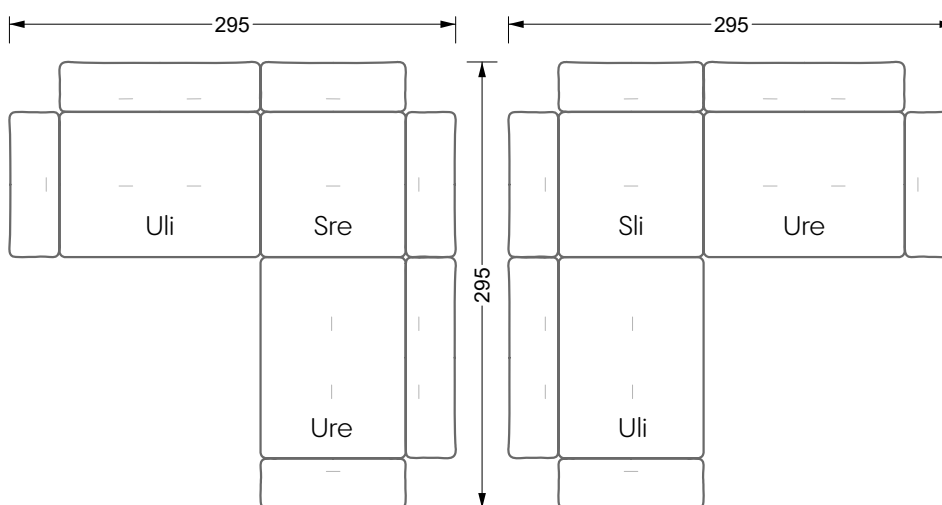
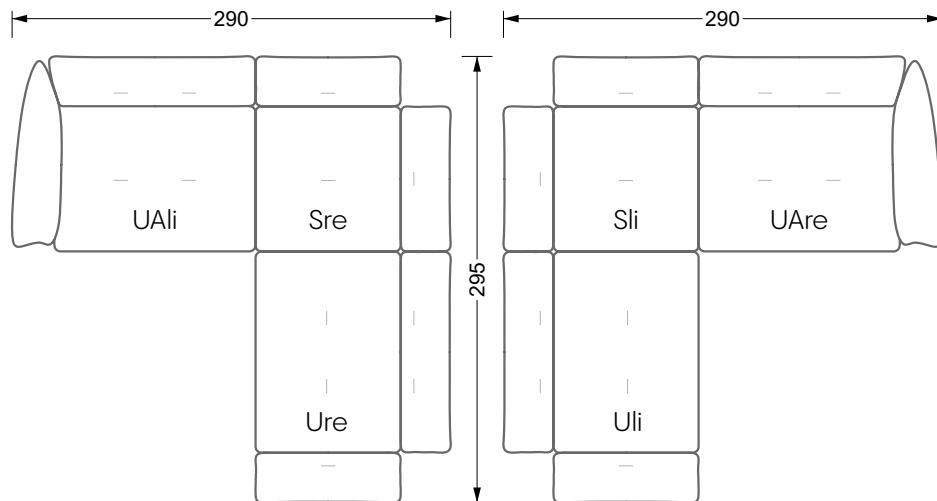
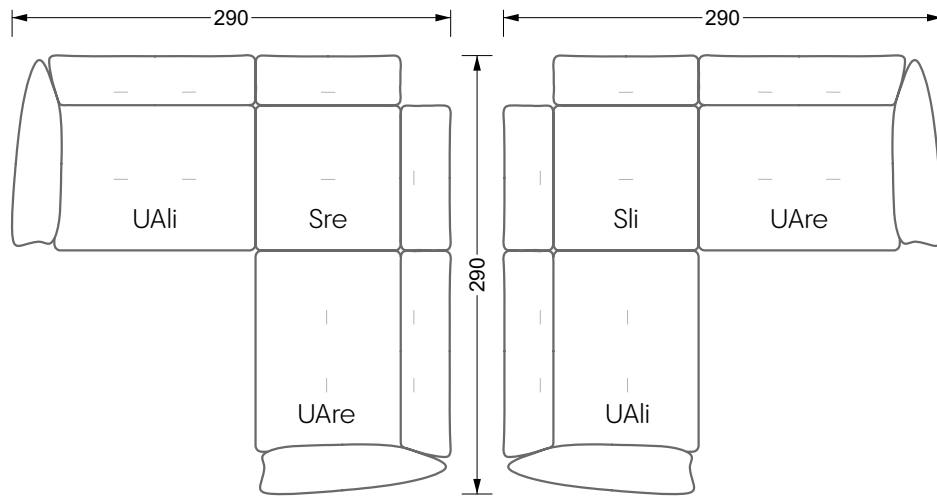

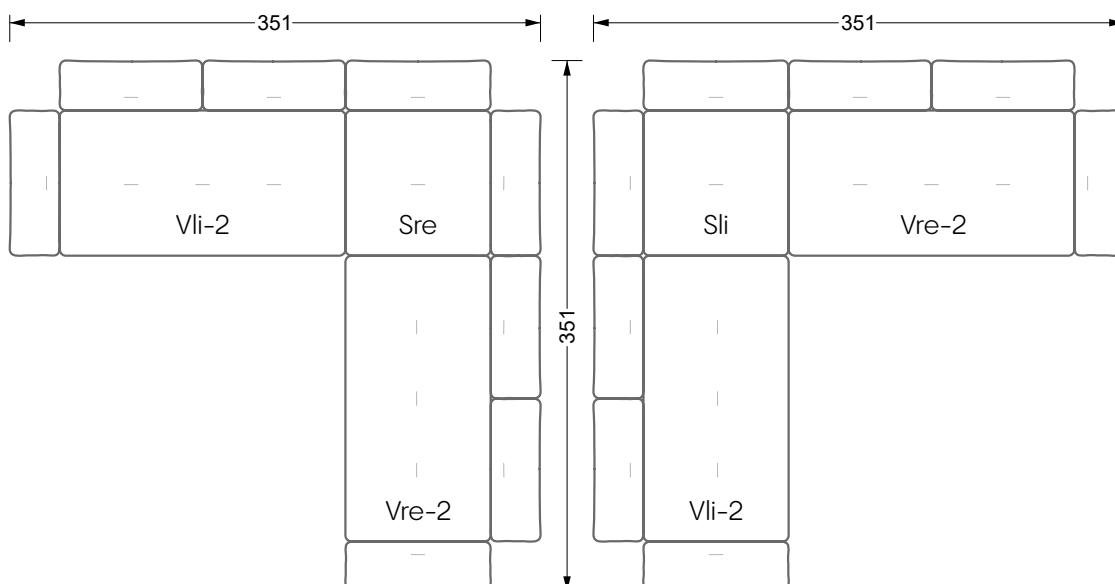
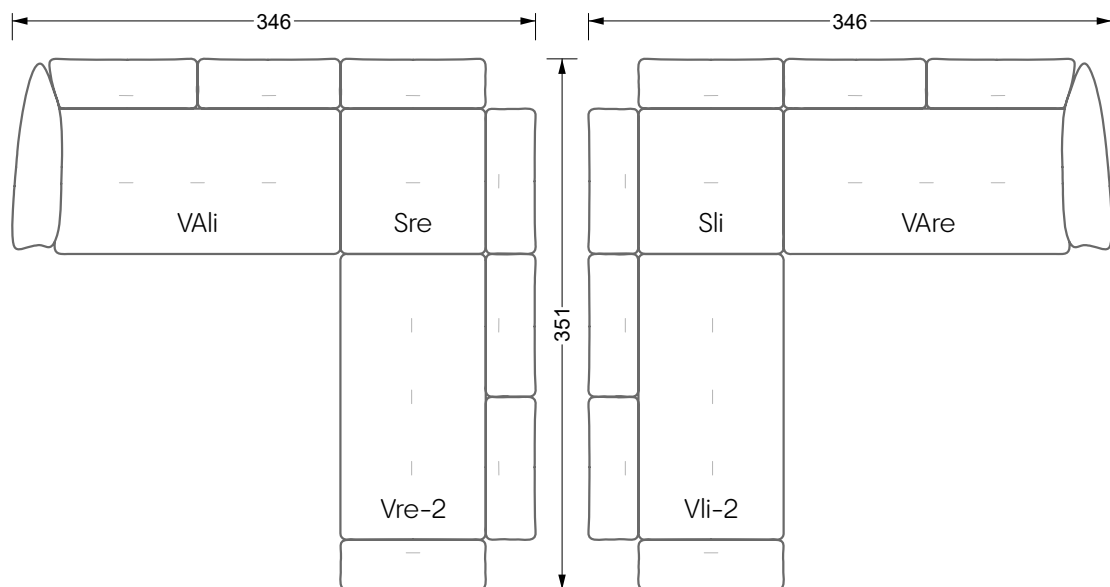
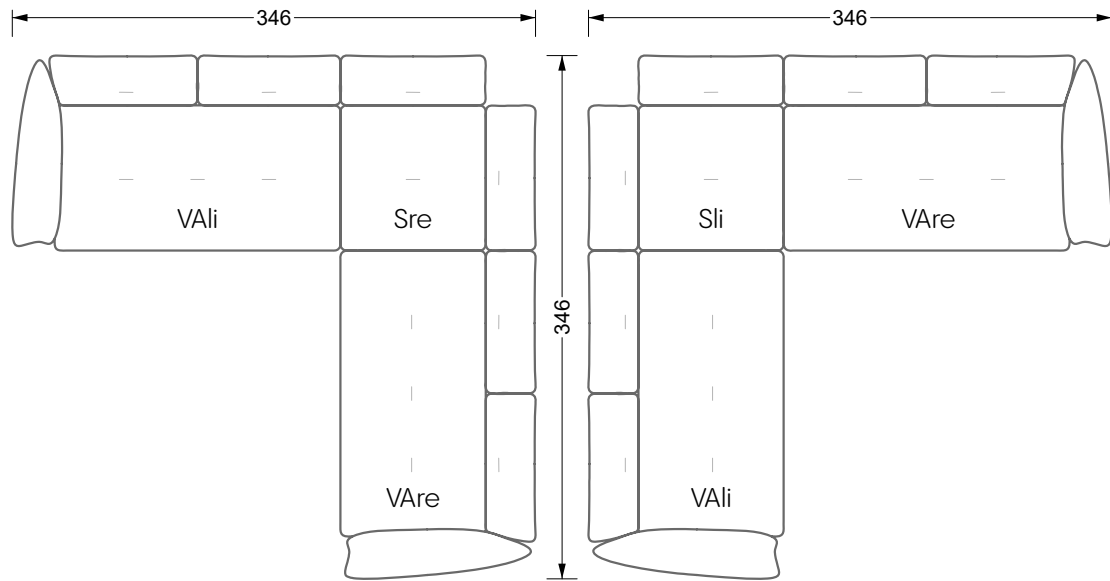





Bretz
German Manufacture
Since 1895

Head Office & Showroom:
Alexander-Bretz-Str. 2
D-55457 Gensingen
Tel +496727-895-0
E-Mail info@bretz.de

Bretz Sales Flagships & Partners:
bretz.de

 [BretzSofas](https://www.facebook.com/BretzSofas)
 [@bretz_sofas](https://www.instagram.com/@bretz_sofas)

Bretz
True Characters